

Congratulations on the purchase of the Tech⁴O NORTHSTAR CW1 or CW2 compass watch.

Please read these instructions and save for future reference.

For best performance, we recommend that you:

- Avoid exposing the watch to extreme conditions for extended periods
- Avoid rough use or severe impacts
- Do not open the watch case unless certified to repair electronic instruments
- Clean with a soft damp cloth
- Keep watch away from magnetic fields such as mobile phones, speakers and motors
- Store in a dry place

NORTHSTAR CW1 & CW2



NORTHSTAR FEATURES

Current Time Mode

Time System:

- Hour - minute - second. AM [A] PM [P]
- 12 hour or 24 hour format
- Animated 1 second bar graph

Calendar System :

- Month - date - day of week. Auto correction for leap year and day of week

Compass Mode

- 16 compass directions- 4 cardinal and 12 ordinal points
- Magnetic North pointer
- Compass lock
- Backward bearing
- Declination setting and calibration

Daily Alarm Mode

- Daily alarm
- Hourly beep

Chronograph Mode

- Measurement unit - 1/100 second
- Measuring capacity - 99 hours, 59 minutes & 59.99 seconds

Timer Mode

- Measurement unit - 1 second
- Measuring capacity - 99 hours, 59 minutes & 59 seconds

Pace Mode

- Pace beat - 40 to 180 beats per minute

Dual time Mode

Time System

- Hour - minute - second. AM [A] PM [P]
- Animated 1 second bar graph

FUNCTIONS MAP

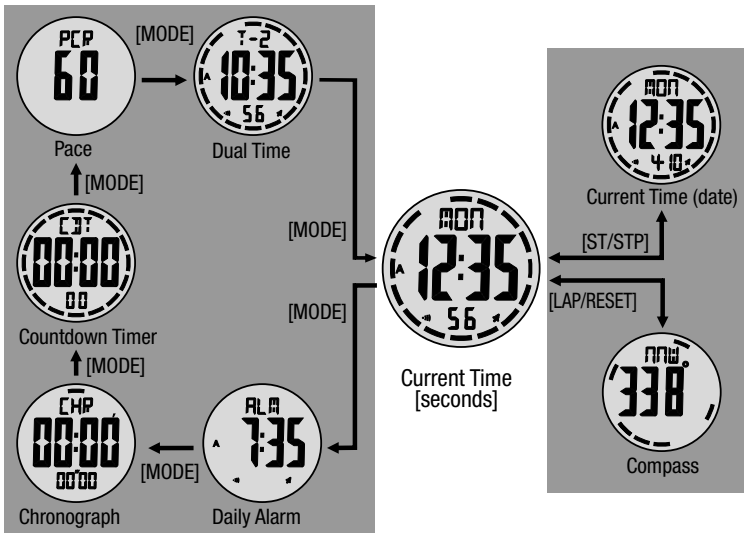

CURRENT TIME MODE

Press [ST/STP] button to toggle between Seconds Display and Date Display

Time Display

- 1st row displays: day of week
- 2nd row displays: hour - minute
- 3rd row displays: second
- Animated (1 second) - displays in the perimeter bar graph

Date Display

- Day of week, hour, minute - display in the 1st and 2nd rows
- Numerical day, month - display in the 3rd row
- Animated (1 second) - displays in the perimeter bar graph

NOTE: Press and Hold [ST/STP] to toggle the date format between month - day and day - month

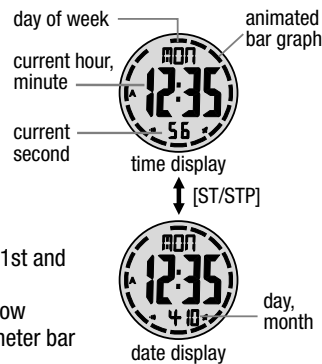

To Set the Current Time Mode

- In the current time mode, Press and Hold [MODE] for 2 seconds until the "seconds" digits flash
- Press [ST/STP] or [LAP/RESET] to reset the seconds to zero; OR Press [MODE] to navigate to any setting you wish to change. See navigation chart at right
- When the setting you wish to change flashes, Press [ST/STP] to raise the value or [LAP/RESET] to lower the value.

Note: If you Press and Hold the button, the rate of change is faster

- When 12 or 24 flashes, Press [ST/STP] or [LAP/RESET] to toggle between the 12 /24 hour format. Press [MODE] to confirm

NOTE: If NO INPUT for 1 minute during setup, the display will default to the Current Time Mode

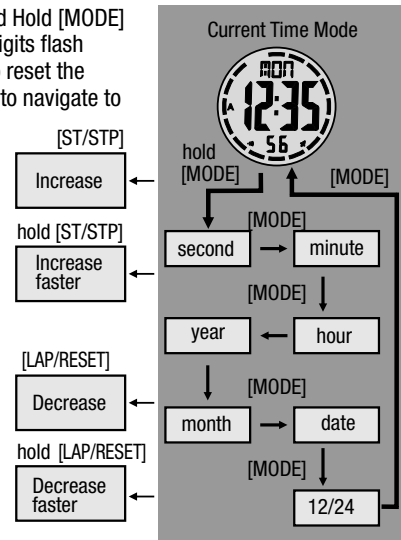

DAILY ALARM MODE

When the daily alarm is ON, the watch will beep for 20 seconds at the assigned time.

When the hourly beep is ON, the watch will beep twice every hour on the hour

Daily Alarm Display

Daily alarm setting (hour - minute) - displays in the 2nd row

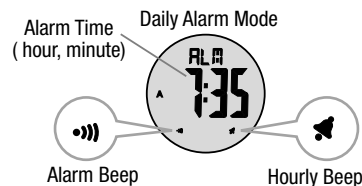

To Set the Daily Alarm Mode

- In the Daily Alarm Mode, Press and Hold [MODE] for 2 seconds until the "seconds" digits flash
- Press [ST/STP] or [LAP/RESET] to reset the seconds to zero; OR Press [MODE] to navigate to any setting you wish to change. See navigation chart at right
- When the setting you wish to change flashes, Press [ST/STP] to raise the value or [LAP/RESET] to lower the value.

Note: If you Press and Hold the button, the rate of change is faster

To turn Daily Alarm ON/OFF

- Press [ST/STP] while in the Daily Alarm Mode
- When the icon appears, the Daily Alarm is ON

To turn Hourly Beep ON/OFF

- Press [LAP/RESET] while in the Daily Alarm Mode
- When the icon appears, the hourly beep is ON

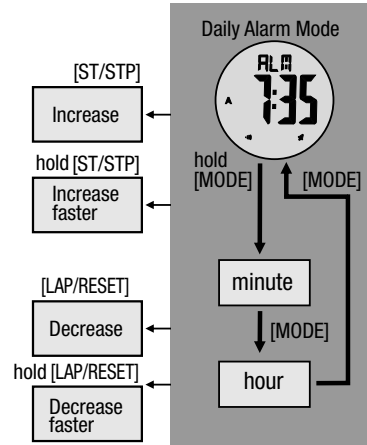

DUAL TIME MODE

To Set the Dual Time Mode

- In Dual Time Mode, Press and Hold [MODE] for 2 seconds until the "minutes" digits flash
 - Press [MODE] to navigate to the setting that you wish to change. See navigation chart at right
 - When the setting you wish to change flashes, Press [ST/STP] to raise the value or [LAP/RESET] to lower the value.
- Note: If you Press and Hold the button, the rate of change is faster
- When the hour is set, Press [MODE] to confirm and return to the Dual Time Mode

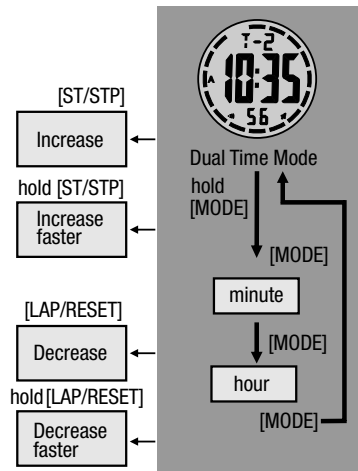

NOTE: If NO INPUT for 1 minute during the setup, the display will default to the Dual Time Mode

COMPASS MODE

This watch is a digital compass that provides directions, bearings and Magnetic North Pole location.

Caution: Accurate readings will be compromised when used near magnetic fields, mobile phones, speakers, motors, electrical appliances and inside a moving vehicle or a ferroconcrete building.

Watch may need to be calibrated for declination

Perform calibration when:

- first time of use
- DIST** is flashing
- Declination has changed
- Battery has been changed

Compass Display

To access, press [LAP/RESET] when in current time mode.

- Compass direction - displays in 1st row
- Compass bearing - displays in 2nd row
- Animated cardinal points - display in perimeter bar graph

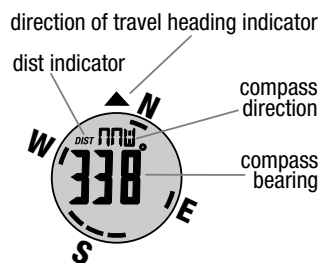

Compass Mode
1 minute ↓ ↑ any button except [LIGHT]

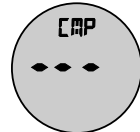

Compass Stand-by Mode

Compass Standby Mode

- To extend battery life, watch will switch to standby mode if there is NO INPUT for 1 minute when in compass mode
- Press any button except [LIGHT] to exit standby mode

MAGNETIC DECLINATION

The Magnetic sensor in the compass is attracted by the magnetism of the Earth and therefore, always points to the constantly shifting Magnetic North. There is another "North Pole." True North is static and located geographically about 800 miles north of the magnetic pole. Maps and directions usually are based on True North. Magnetic declination is the angle between True North and Magnetic North. The amount of declination at any given point depends on the location of that point.

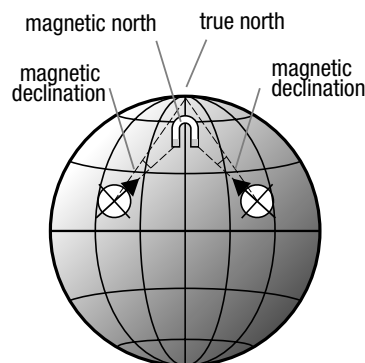

on the continent. Where True and Magnetic North are in the same direction, the declination is zero. At any point west of that line, your compass needle will point east of True North. This is called "Easterly Declination." At any point east of that zero line, your compass needle will point west of True North. This is called "Westerly Declination."

NOTE: The watch displays Westerly Declination as a negative number.
example: -45

MAGNETIC DECLINATION COMPENSATION

The watch will automatically make declination compensation. We have included a list of the declination angles of North America. In the Declination Setting Mode, input the closest angle and the watch will make the adjustment.

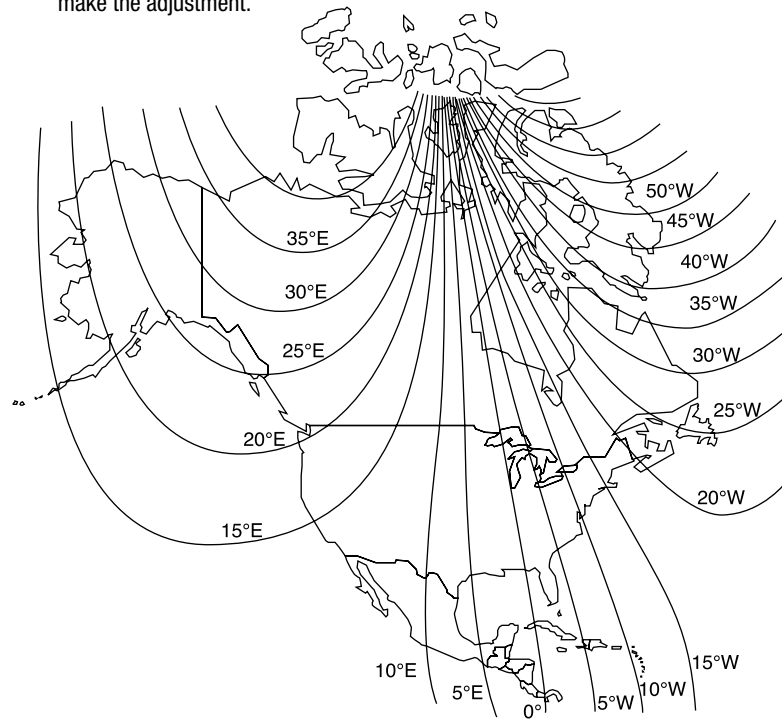

COMPASS CALIBRATION

To Calibrate the Compass

- In the Compass Mode, Press and Hold [MODE] for 2 seconds. DEC will display in the 1st row and the digits will flash
- Press [ST/STP] to set desired declination angle (-90 to +90)
- Press [MODE] CAL will display in the 1st row and the north pole pointer will move
- Lay the watch on a level surface. Steadily rotate the watch counter-clockwise twice. Keep the pointer in the same direction through out the rotation
- Press [MODE] to confirm and return to Compass Mode

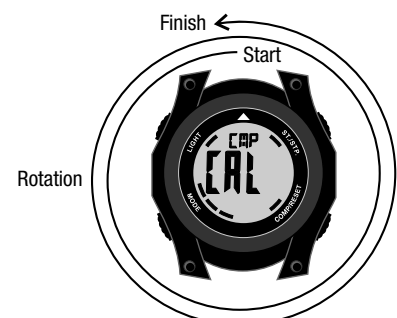
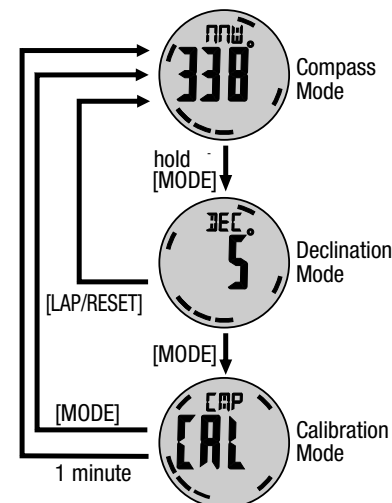

TAKE A BEARING

To Determine the Direction of Travel

- Turn the watch until the navigation arrow points to the direction of travel. Press [COMP/RESET] to enter Compass Mode
- The compass direction displays in the 1st row
- The bearing displays in the 2nd row
- The bar graph will indicate Magnetic North

Important: When taking a bearing, the watch MUST be parallel to the horizon or the data will be inaccurate.

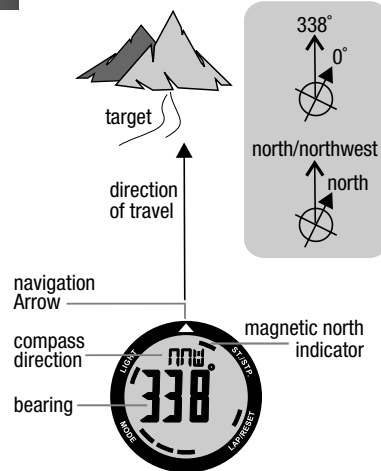

FIND YOUR WAY

Use this watch and a protractor to keep to a trail

Before Hiking

- Locate the distance between and location of the turning points of the trail on a map
 - Use a protractor to determine the bearing of each turn and mark the map. See right
- Start to B = 315° / 1.2 mi
 B to C = 0° / .6mi
 C to D = 225° / .5 mi
 D to finish = 315° / 1.7 mi

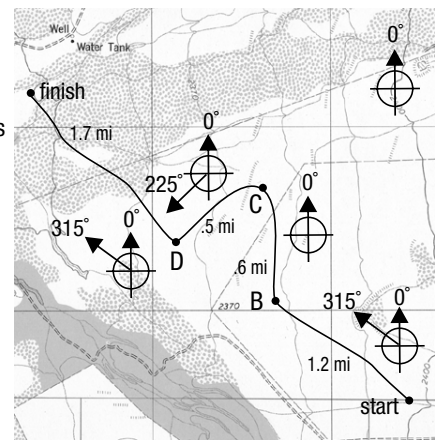

While Hiking

- Use the watch to find the bearing at each turn

LIMITED WARRANTY:

What is covered? Johnson Outdoors Inc. warrants your Tech4o Watch to be free from defects in materials or workmanship, and to perform accurately, for one (1) year provided it has not been damaged by the causes described in the next paragraph.

What is not covered? Normal wear, and damage due to the abrasion, melting, misuse, alteration, and abuse (including any disassembly) are not covered by this warranty.

Digital Watches are water resistant, they are not waterproof. Damage resulting from excessive exposure to water, heat or cold is not covered under this warranty. Additionally, the battery is not covered under the warranty.

How to obtain warranty service or repair of your watch: Should a defect covered by this warranty appear in your watch, call our Consumer Service Department toll-free at 1.800.572.8822 for return authorization and instructions. (You must pay the cost of returning the unit to us). If the product is found to be defective in material or workmanship, we shall, at our option, either repair or replace it without charge, and will pay the cost of return shipment to you. If repairs are required to correct any problem not covered by this warranty, we will contact you for approval to proceed and to charge you for the components repaired or replaced, plus a nominal charge for labor.

THERE ARE NO EXPRESS WARRANTIES ON YOUR WATCH THAT ARE NOT CONTAINED IN THIS DOCUMENT. IN NO EVENT SHALL WE BE LIABLE FOR INCIDENTAL OR CONSEQUENTIAL DAMAGES ARISING FROM USING OR LOSS OF USE OF YOUR WATCH.

Some states do not allow exclusion or limitation of incidental or consequential damages, so the above exclusion may not apply to you.

This warranty gives you specific legal rights, and you may have other rights which vary from state to state.

Contact us: www.tech4o.com

U.S.A.:
 Johnson Outdoors Inc.
 625 Conklin Road
 PO Box 966
 Binghamton, NY 13902
 Phone: 607.779.2222
 Toll Free: 1.800.572.8822
 Fax: 607.779.2293

Canada:
 Johnson Outdoors Canada Inc.
 4180 Harvester Road
 Burlington, Ontario, Canada L7L 6B6
 Phone: 905.634.0023
 Toll Free: 1.800.263.6390
 Fax: 1.800.661.1170



TAKE A REVERSE BEARING

This watch will also display the opposite direction (180°) of a bearing. A reverse bearing is used to accurately backtrack your direction or determine you location on a map

To determine a Backward Bearing

- In Compass Mode, Press [MODE] to toggle between forward and reverse bearings. The icon "↓" displays for Reverse Bearing
- The watch will automatically return to forward bearing after being changed to Standby Mode or Current Time Mode

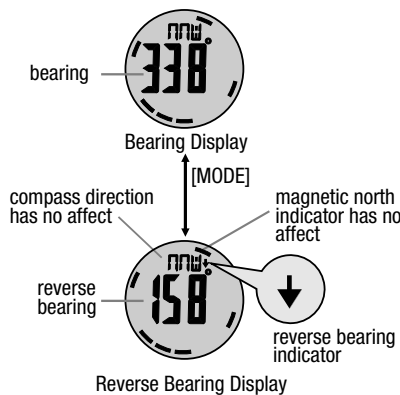

LOCK A BEARING

This watch will provide a "compass lock" function to secure an important bearing. When the "FO" is displayed, the compass reading will not change

To Lock / Unlock the Compass

- When in Compass Mode, Press [ST/STP] to toggle between lock and unlock
- The watch will automatically return to unlock after being changed to Standby Mode or Current Time Mode

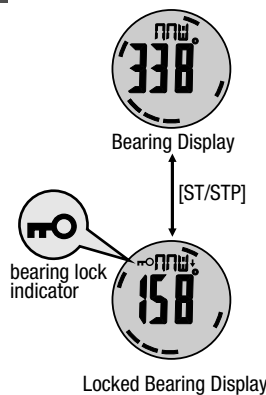

FIND YOUR LOCATION

Use this watch with the reverse bearing feature, a map and protractor, to determine your current position

To Find Your Current Position

- Locate two distant, identifiable landmarks. See diagram at right
- Find each landmark's location on the map
- Use the watch to determine the reverse bearing of each landmark
- With a protractor, draw a line down each reverse bearing onto the map
- Your current position is the intersection of these two lines

